



Main

Range compatibility	Lexium 28
Device short name	BCH2
Product or component type	Servo motor

Complementary

Maximum mechanical speed	5000 rpm
[Us] rated supply voltage	220 V 110 V
Network number of phases	Single phase Three phase
Continuous stall current	2.19 A
Continuous stall torque	1.27 N.M for LXM28... at 2.6 A, 220 V, single phase 1.27 N.M for LXM28... at 2.6 A, 220 V, three phase 1.27 N.m for LXM28... at 5.7 A, 110 V, single phase
Continuous power	400 W
Peak stall torque	3.81 N.M for LXM28... at 2.6 A, 220 V, single phase 3.81 N.M for LXM28... at 2.6 A, 220 V, three phase 3.81 N.m for LXM28... at 5.7 A, 110 V, single phase
Nominal output power	400 W for LXM28... at 2.6 A, 220 V, single phase 400 W for LXM28... at 2.6 A, 220 V, three phase 400 W for LXM28... at 5.7 A, 110 V, single phase
Nominal torque	1.27 N.M for LXM28... at 2.6 A, 220 V, single phase 1.27 N.M for LXM28... at 2.6 A, 220 V, three phase 1.27 N.m for LXM28... at 5.7 A, 110 V, single phase
Nominal speed	3000 rpm for LXM28... at 2.6 A, 220 V, single phase 3000 rpm for LXM28... at 2.6 A, 220 V, three phase 3000 rpm for LXM28... at 5.7 A, 110 V, single phase
Maximum current Irms	7.76 A for LXM28... at 0.4 kW, 220 V 7.76 A for LXM28... at 0.4 kW, 110 V
Maximum permanent current	2.5 A
Product compatibility	LXM28... servo drive motor at 0.4 kW, 220 V, single phase LXM28... servo drive motor at 0.4 kW, 220 V, three phase LXM28... servo drive motor at 0.4 kW, 110 V, single phase
Shaft end	Keyed
Shaft diameter	14 mm
Shaft length	30 mm
Key width	5 mm
Feedback type	20 bits single turn absolute encoder
Holding brake	Without
Mounting support	Asian standard flange
Motor flange size	60 mm

Electrical connection	Free lead
Torque constant	0.58 N.m/A at 20 °C
Back emf constant	35 V/krpm at 20 °C
Rotor inertia	0.27 kg.cm ²
Stator resistance	5.2 Ohm at 20 °C
Stator inductance	12 mH at 20 °C
Stator electrical time constant	2.31 ms at 20 °C
Maximum radial force Fr	200 N at 3000 rpm
Maximum axial force Fa	70 N
Brake pull-in power	11.2 W
Type of cooling	Natural convection
Length	129 mm
Number of motor stacks	2
Centring collar diameter	50 mm
Centring collar depth	5.5 mm
Number of mounting holes	4
Mounting holes diameter	5.5 mm
Circle diameter of the mounting holes	70 mm
Distance shaft shoulder-flange	5.5 mm
Net weight	1.45 kg





Environment

IP degree of protection	IP54 IM B5, IM V1 IP50 IM V3
Ambient air temperature for operation	-20...40 °C

Packing Units

Unit Type of Package 1	PCE
Number of Units in Package 1	1
Package 1 Height	11.1 cm
Package 1 Width	14.5 cm
Package 1 Length	26.5 cm
Package 1 Weight	2.08 kg

Offer Sustainability

Sustainable offer status	Green Premium product
REACH Regulation	 REACH Declaration
REACH free of SVHC	Yes
EU RoHS Directive	Pro-active compliance (Product out of EU RoHS legal scope)
Mercury free	Yes
China RoHS Regulation	 China RoHS Declaration
RoHS exemption information	 Yes
Environmental Disclosure	 Product Environmental Profile
Circularity Profile	 End Of Life Information
WEEE	The product must be disposed on European Union markets following specific waste collection and never end up in rubbish bins
PVC free	Yes

Dimensions

Dimensions of Motor

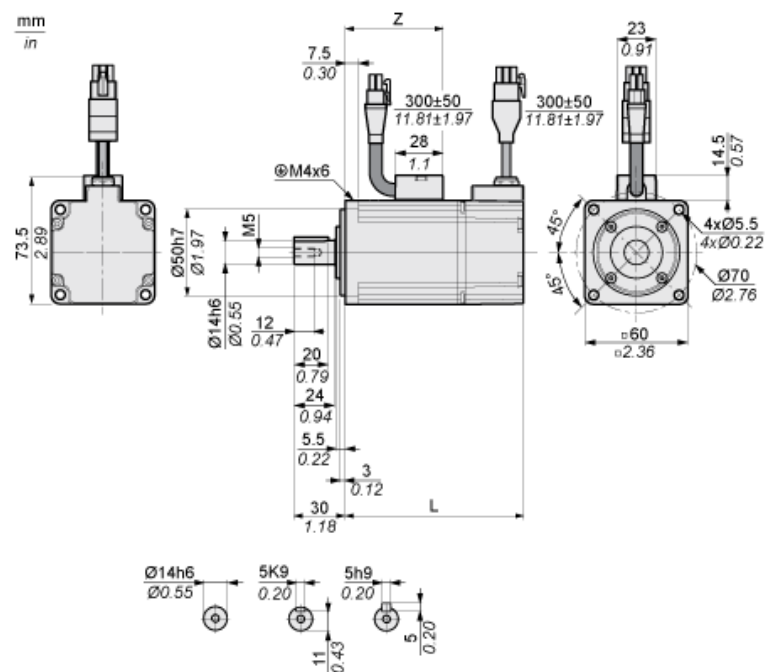

	mm	in.
L (without holding brake)	129	5.08
L (with holding brake)	165	6.5
Z	82	3.23

Torque/Speed Curves with 230 V Single/Three Phase Supply Voltage

Servo Motor with LXM28AU04●●● Servo Drive

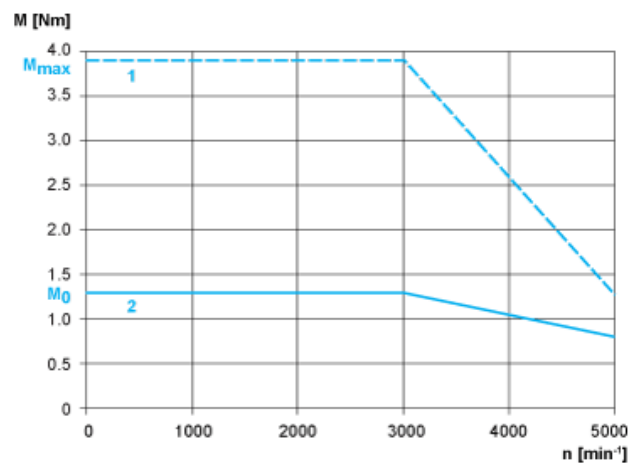

- 1 : Peak torque
- 2 : Continuous torque