

KTA1250EL75

Feed unit for dry type transformers, Canalis KTA, aluminium, 1250A, 3L+N+PER, high I_{cw}, made to measure, N5, RAL9001

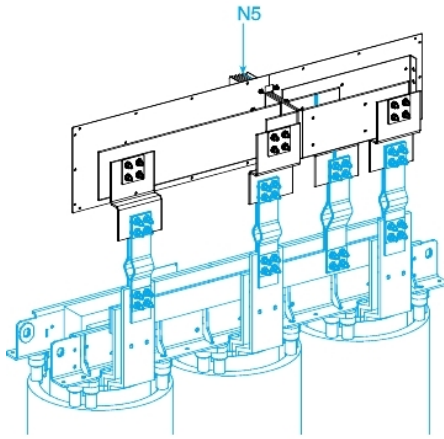

Main

Range	Canalis
Product name	KT
Product or component type	Flat feeder trunking
Device short name	KTA
Device application	Feeder length
Supply	Dry-type transformer
Material	Aluminium
[I _e] rated operational current	1250 A at 35 °C
Neutral position	Right
Earth conductor	Reinforced
Short-circuit level	Reinforced version
Provided equipment	Trunking unit

Complementary

Housing material	Polyester film
Contacts material	Copper
[U _e] rated operational voltage	1000 V
Network frequency	50/60 Hz
[U _i] rated insulation voltage	1000 V
[I _{cw}] rated short-time withstand current	65 kA
[I _{pk}] rated peak withstand current	143 kA
Radiated magnetic field	0.75 μT
Thermal stress limit	4225000 kA ² .s
THDI	0...15 % 1250 A 15...33 % 1600 A 33...100 % 2000 A
Maximum voltage drop	<0.0049 V with power factor = 1 at 50 Hz with 1A for 100 m long <0.005 V with power factor = 0.9 at 50 Hz with 1A for 100 m long <0.0047 V with power factor = 0.8 at 50 Hz with 1A for 100 m long <0.0043 V with power factor = 0.7 at 50 Hz with 1A for 100 m long
Mounting mode	By screws
Mounting support	Plate
Polarity	3L + N + PER
Number of tap-off outlets	0
Standards	IEC 61439-6 IEC 61439-1
Dimension type	Made to measure
Connection pitch	390...700 mm
Bar width	160 mm
Depth	150 mm
Height	230 mm
Length	Direction 1: 235 mm 1600 mm
Colour	White (RAL 9001)
Linear load	21 kg/m

The information provided in this documentation contains general descriptions and/or technical characteristics of the products of the performance of the products contained herein. This documentation is not intended as a substitute for and is not to be used for determining suitability or reliability of these products for specific user applications. It is the duty of any such user or integrator to perform the appropriate and complete risk analysis, evaluation and testing of the products with respect to the relevant specific application or use thereof. Neither Schneider Electric Industries SAS nor any of its affiliates or subsidiaries shall be responsible or liable for misuse of the information contained herein.

Environment

IP degree of protection	IP55 conforming to IEC 60529
IK degree of protection	IK08 conforming to IEC 62262
Derating factor	0...35 °C (100 % of In) 35...40 °C (97 % of In) 40...45 °C (93 % of In) 45...50 °C (90 % of In) 50...55 °C (86 % of In)

Packing Units

Unit Type of Package 1	PCE
Number of Units in Package 1	1
Package 1 Height	33.0 cm
Package 1 Width	168.0 cm
Package 1 Length	40.0 cm
Package 1 Weight	45.0 kg

Offer Sustainability

Sustainable offer status	Green Premium product
REACH Regulation	REACH Declaration
REACH free of SVHC	Yes
EU RoHS Directive	Compliant EU RoHS Declaration
Mercury free	Yes
China RoHS Regulation	China RoHS Declaration
RoHS exemption information	Yes
Environmental Disclosure	Product Environmental Profile
Circularity Profile	End Of Life Information
WEEE	The product must be disposed on European Union markets following specific waste collection and never end up in rubbish bins