

KTC1000YA5

Junction block, Canalis KTA, single reference, 1000A, copper conductors, 3L+N+PE Reinforced (Al)

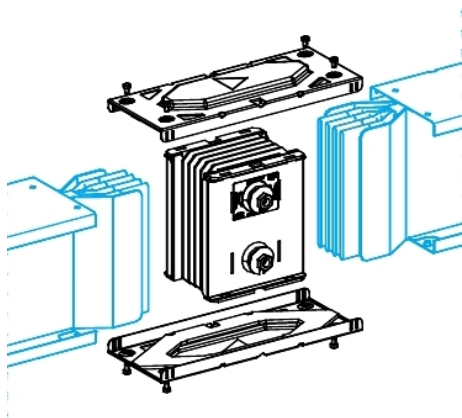

Main

Range	Canalis
Product name	KT
Product or component type	Junction block
Offer type	Spare part
Busbar description	Standard
Range compatibility	Canalis KTC
Accessory / separate part category	Connection accessory
Device application	Joining
Material	Copper
[Ie] rated operational current	1000 A with copper
Polarity	3L + N + PER
PE conductor	Reinforced
lcw short-circuit version	Standard version
IP degree of protection	IP55 conforming to IEC 60529
Length	360 mm

Complementary

Housing material	Polyester film
Mounting support	Self-tapping screw
[Ue] rated operational voltage	1000 V
Number of circuits	1
Colour	White (RAL 9001)
Width	140 mm
Height	74 mm
Standards	IEC 61439-1 IEC 61439-6

Environment

IK degree of protection	IK08 conforming to IEC 62262
-------------------------	------------------------------

Packing Units

Unit Type of Package 1	PCE
Number of Units in Package 1	1
Package 1 Height	10.4 cm
Package 1 Width	14.0 cm
Package 1 Length	40.0 cm
Package 1 Weight	5.65 kg

The information provided in this documentation contains general descriptions and/or technical characteristics of the products contained herein. This documentation is not intended as a substitute for and is not to be used for determining suitability or reliability of these products for specific user applications. It is the duty of any such user or integrator to perform the appropriate and complete risk analysis, evaluation and testing of the products with respect to the relevant specific application or use thereof. Neither Schneider Electric Industries SAS nor any of its affiliates or subsidiaries shall be responsible or liable for misuse of the information contained herein.

Offer Sustainability

REACH Regulation	REACH Declaration
EU RoHS Directive	Compliant with Exemptions
China RoHS Regulation	China RoHS Declaration
Environmental Disclosure	Product Environmental Profile
Circularity Profile	End Of Life Information
WEEE	The product must be disposed on European Union markets following specific waste collection and never end up in rubbish bins