



## Main

Range of product	Harmony XB4
Product or component type	Head for illuminated selector switch
Product compatibility	Integral LED
Device short name	ZB4F
Bezel material	Chromium plated metal
Head type	Built-in-flush
Mounting diameter	30.5 mm
Sale per indivisible quantity	1
Shape of signaling unit head	Round
Type of operator	To centre spring return
Operator profile	Green standard handle
Operator position information	3 positions +/- 45°

## Complementary

CAD overall width	36.6 mm
CAD overall height	36.6 mm
CAD overall depth	47 mm
Net weight	0.078 kg
Resistance to high pressure washer	7000000 Pa at 55 °C, distance : 0.1 m
Mechanical durability	500000 cycles
Electrical composition code	M3 for <4 contacts using single blocks in front mounting with integral LED M6 for <2 contacts using single blocks in front mounting with integral LED and transformer M10 for <2 contacts using single blocks in front mounting with integral LED M4 for <4 contacts using single and double blocks in front mounting with integral LED
Device presentation	Basic element

## Environment

Protective treatment	TH
Ambient air temperature for storage	-40...70 °C
Ambient air temperature for operation	-40...70 °C
Overvoltage category	Class I conforming to IEC 60536
IP degree of protection	IP66 conforming to IEC 60529 IP67 conforming to IEC 60529 IP69 conforming to IEC 60529 IP69K conforming to ISO 20653 Type 13 conforming to UL 50 E Type 12 conforming to UL 50 E Type 4 conforming to UL 50 E Type 4X conforming to UL 50 E
IK degree of protection	IK06 conforming to IEC 50102

Standards	CSA C22.2 No 14 EN/IEC 60947-5-1 EN/IEC 60947-5-4 UL 508 EN/IEC 60947-1 JIS C8201-5-1 CE JIS C8201-1
Product certifications	UL listed CSA CCC EAC
Vibration resistance	5 gn (f= 10...500 Hz) conforming to IEC 60068-2-6 2 mm peak to peak (f= 2...10 Hz) conforming to IEC 60068-2-6
Shock resistance	30 gn (duration = 18 ms) for half sine wave acceleration conforming to IEC 60068-2-27 50 gn (duration = 11 ms) for half sine wave acceleration conforming to IEC 60068-2-27 25 gn (duration = 6 ms) for 1000 shocks on each axis conforming to IEC 60068-2-27

### Packing Units

Unit Type of Package 1	PCE
Number of Units in Package 1	1
Package 1 Weight	78 g
Package 1 Height	4.4 cm
Package 1 width	5.2 cm
Package 1 Length	5.5 cm

### Offer Sustainability

Sustainable offer status	Green Premium product
REACH Regulation	<a href="#">REACH Declaration</a>
REACH free of SVHC	Yes
EU RoHS Directive	Pro-active compliance (Product out of EU RoHS legal scope) <a href="#">EU RoHS Declaration</a>
Toxic heavy metal free	Yes
Mercury free	Yes
RoHS exemption information	<a href="#">Yes</a>
China RoHS Regulation	<a href="#">China RoHS Declaration</a>
Environmental Disclosure	<a href="#">Product Environmental Profile</a>
Circularity Profile	<a href="#">End Of Life Information</a>

### Contractual warranty

Warranty	18 months
----------	-----------

Dimensions

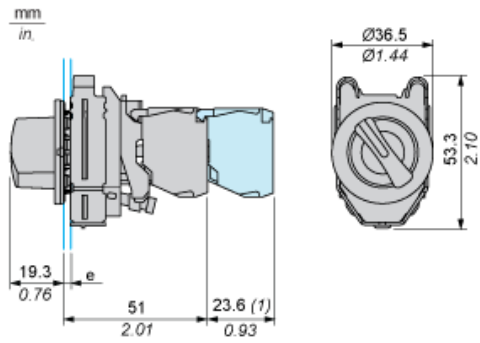

e : clamping thickness: 1 to 6 mm / 0.04 to 0.24 in.  
(1) : Additional row of contacts

Panel Cut-out for Pushbuttons, Switches and Pilot Lights (Finished Holes, Ready for Installation)

Connection by Screw Clamp Terminals or Plug-in Connectors

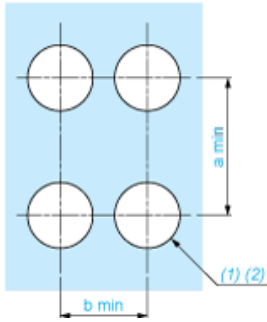

(1) : Diameter on finished panel or support

(2) :  $\text{Ø}30.75 \text{ mm}$  recommended ( $\text{Ø}30.5 \text{ }_0^{+0.5}$ ) /  $\text{Ø}1.21 \text{ in.}$  recommended ( $\text{Ø}1.20 \text{ in. }_0^{+0.0196}$ )

Connections	a in mm	a in in.	b in mm	b in in.
By connectors	50	1.97	40	1.57
By connectors and with legend holder ZBZF32	50	1.97	40	1.57
By connectors and with legend holder ZBZF33	60	2.36	40	1.57

---

Electrical Composition Corresponding to Code M3

---

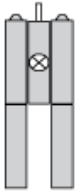

---

Electrical Composition Corresponding to Code M4

---

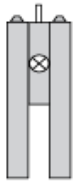

---

Electrical Composition Corresponding to Codes M6 and P2

---

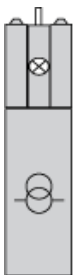

---

Electrical Composition Corresponding to Codes M5, M10, MF1, MR1 and MF2

---

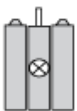

---

Legend

---

Single contact



Double contact



Light block







Possible location



### Sequence of Contacts Fitted to 3-position Selector Switch Body





#### Position 315°



Push	Position	Top			
Bottom					
Location		Left	Right		
State		1	0		
Contacts	N/O		closed	open	
N/C		open	closed		





#### Position 0°



Push	Position	Top			
Bottom					
Location		Left	Right		
State		0	0		
Contacts	N/O		open	open	
N/C		closed	closed		

Position 45°



Push	Position	Top			
Bottom					
Location		Left	Right		
State		0	1		
Contacts	N/O		open	closed	
N/C		closed	open		