

XCKML121H29

Limit switch, Limit switches XC Standard, XCKML, thermoplastic roller lever plunger, 2x(1NC+1NO), snap, M20

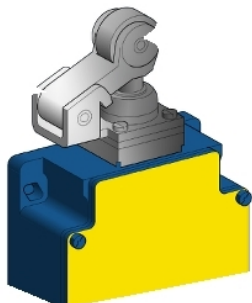

Main

Range of product	Telemecanique Limit switches XC Standard
Series name	Standard format
Product or component type	Limit switch
Device short name	XCKML
Body type	Fixed
Head type	Plunger head
Material	Metal
Body material	Zamak
Fixing mode	By the body
Movement of operating head	Linear
Type of operator	Spring return roller lever plunger thermoplastic
Type of approach	Lateral approach, 1 direction
Cable entry	3 entries tapped for M20 x 1.5 cable gland, cable outer diameter: 7...13 mm
Number of poles	4
Contacts type and composition	2 x (1 NC + 1 NO)
Contact operation	Snap action

Complementary

Switch actuation	By 30° cam
Electrical connection	Screw-clamp terminals, clamping capacity: 1 x 0.34...2 x 1.5 mm ²
Contacts insulation form	Zb
Number of steps	1
Positive opening	With
Positive opening minimum force	50 N
Minimum force for tripping	8 N
Minimum actuation speed	0.01 m/min
Maximum actuation speed	1.5 m/s
[I _{th} e] conventional enclosed thermal current	10 A AC
[U _i] rated insulation voltage	300 V conforming to UL 508 500 V (pollution degree 3) conforming to IEC 60947-1 300 V conforming to CSA C22.2 No 14
Maximum resistance across terminals	25 MOhm conforming to IEC 60255-7 category 3
[U _{imp}] rated impulse withstand voltage	IEC 60664 6 kV IEC 60947-1 6 kV
Electrical durability	5000000 Cycles, DC-13, inductive load type, 120 V, 4 W, operating rate <60 cyc/mn, load factor: 0.5 conforming to IEC 60947-5-1 appendix C 5000000 Cycles, DC-13, inductive load type, 24 V, 7 W, operating rate <60 cyc/mn, load factor: 0.5 conforming to IEC 60947-5-1 appendix C 5000000 cycles, DC-13, inductive load type, 48 V, 10 W, operating rate <60 cyc/mn, load factor: 0.5 conforming to IEC 60947-5-1 appendix C
Mechanical durability	3000000 cycles
Width	77 mm
Height	81 mm
Depth	36 mm

Net weight	0.45 kg
Terminals description ISO n°1	(21-22)NC (13-14)NO





Environment

Shock resistance	50 gn for 11 ms conforming to EN/IEC 60068-2-27
Vibration resistance	25 gn (f= 10...500 Hz) conforming to EN/IEC 60068-2-6
IP degree of protection	IP66 conforming to EN/IEC 60529
IK degree of protection	IK05 conforming to EN 50102
Electrical shock protection class	Class I conforming to IEC 61140 Class I conforming to NF C 20-030
Ambient air temperature for operation	-25...70 °C
Ambient air temperature for storage	-40...70 °C
Protective treatment	TC
Product certifications	UL CSA
Standards	IEC 60947-5-1 EN 60947-5-1 UL 508 EN 60204-1 IEC 60204-1 CSA C22.2 No 14

Packing Units

Unit Type of Package 1	PCE
Number of Units in Package 1	1
Package 1 Weight	440 g
Package 1 Height	14.5 cm
Package 1 width	8 cm
Package 1 Length	4.4 cm

Offer Sustainability

Sustainable offer status	Green Premium product
REACH Regulation	 REACH Declaration
EU RoHS Directive	Pro-active compliance (Product out of EU RoHS legal scope)  EU RoHS Declaration
Mercury free	Yes
RoHS exemption information	 Yes
Environmental Disclosure	 Product Environmental Profile

Contractual warranty

Warranty	18 months
----------	-----------

Dimensions

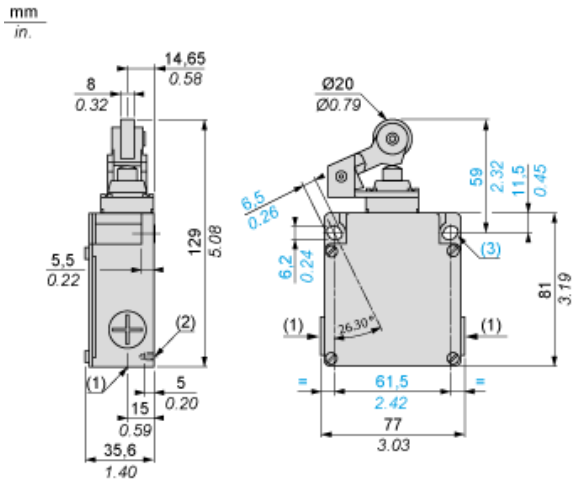

- (1) 3 tapped entries M20 x 1.5
- (2) 2 centring holes $\varnothing 3.9 \pm 0.2$, for cover fixing holes alignment.
- Ø : 2 elongated holes 6.2 x 6.5, inclined at 26° 30' to the vertical axis, for M5 screws.

Mounting with Cable Entry

Position of Cable Gland



- (1) Recommended
- (2) To be avoided

Wiring Diagram

2 x 2-pole NC + NO Snap Action

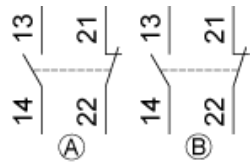

Characteristics of Actuation

Switch Actuation by 30° Cam

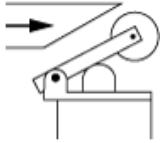

Functionnal Diagram

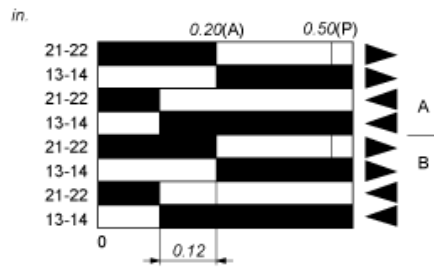
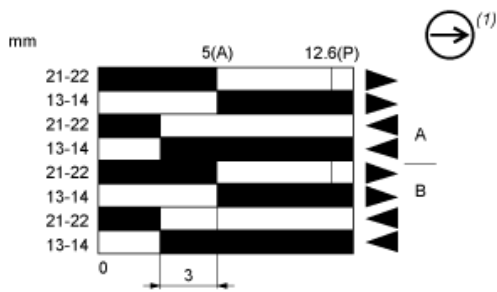

- (2)
- (3)
- ▶ (4)
- ◀ (5)

- (P) Positive opening point
- (A) Cam displacement
- (1) NC contact with positive opening operation
- (2) Closed
- (3) Open
- (4) Tripping
- (5) Resetting