

# XMLC300D2S11

Electromechanical pressure sensor, Pressure sensors XM, switch XMLC 300 bar, adjustable scale 2 thresholds, 2 C/O



## Main

Range of product	OsiSense XM
Product or component type	Electromechanical pressure sensor
Pressure sensor type	Electromechanical pressure sensor
Device short name	XMLC
Pressure rating	300 bar
Controlled fluid	Hydraulic oil (0...160 °C)
Fluid connection type	G 1/4 (female) conforming to ISO 228
Electrical connection	Screw-clamps terminals, 1 x 0.5...2 x 2.5 mm <sup>2</sup>
AWG gauge	AWG 20...AWG 14
Cable entry	Cable gland 9...13 mm
Contacts type and composition	2 C/O
Product specific application	-
Pressure switch type of operation	Regulation between 2 thresholds
Electrical circuit type	Control circuit
Scale type	Adjustable differential
Local display	With
Adjustable range of switching point on rising pressure	22...300 bar
Adjustable range of switching point on falling pressure	6...265 bar
Possible differential maximum at high setting	240 bar
Maximum permissible accidental pressure	675 bar
Destruction pressure	1350 bar
Pressure actuator	Piston
Materials in contact with fluid	Brass PTFE Steel FPM, FKM
Enclosure material	Zinc alloy
[In] rated current	3 A, B300, AC-15 (Ue = 120 V) conforming to EN/IEC 60947-5-1 1.5 A, B300, AC-15 (Ue = 240 V) conforming to EN/IEC 60947-5-1 0.1 A, R300, DC-13 (Ue = 250 V) conforming to EN/IEC 60947-5-1

## Complementary

Possible differential minimum at low setting	16 bar (+/- 0.9 bar)
Possible differential minimum at high setting	35 bar (+/- 0.9 bar)
Maximum permissible pressure - per cycle	375 bar
Terminal block type	8 terminals
Maximum operating rate	60 cyc/mn

Repeat accuracy	2 %
[Ui] rated insulation voltage	300 V conforming to UL 508 500 V conforming to EN/IEC 60947-1 300 V conforming to CSA C22.2 No 14
[Uimp] rated impulse withstand voltage	EN/IEC 60947-1 6 kV
Auxiliary contacts operation	Simultaneous, snap action
Contacts material	Silver contacts
Maximum resistance across terminals	25 MOhm conforming to IEC 255-7 category 3 25 mOhm conforming to NF C 93-050 method A
Short-circuit protection	10 A cartridge fuse, type gG (gl)
Mechanical durability	3000000 cycles
Setting	External
Height	113 mm
Depth	85 mm
Width	46 mm
Net weight	0.75 kg





## Environment

Standards	UL 508 CE CSA C22.2 No 14 EN/IEC 60947-5-1
Product certifications	EAC CSA UL
Protective treatment	TC standard version
Ambient air temperature for operation	-25...70 °C
Ambient air temperature for storage	-40...70 °C
Operating position	Any position
Vibration resistance	4 gn conforming to IEC 60068-2-6 (f = 30...500 Hz)
Shock resistance	50 gn conforming to IEC 60068-2-27
Electrical shock protection class	Class I conforming to IEC 1140 Class I conforming to IEC 536 Class I conforming to NF C 20-030
IP degree of protection	IP66 conforming to EN/IEC 60529

## Packing Units

Unit Type of Package 1	PCE
Number of Units in Package 1	1
Package 1 Weight	870 g
Package 1 Height	6 cm
Package 1 width	15 cm
Package 1 Length	10.7 cm

## Offer Sustainability

Sustainable offer status	Green Premium product
REACH Regulation	 <a href="#">REACH Declaration</a>
EU RoHS Directive	Pro-active compliance (Product out of EU RoHS legal scope)  <a href="#">EU RoHS Declaration</a>
Mercury free	Yes
RoHS exemption information	 Yes
Environmental Disclosure	 <a href="#">Product Environmental Profile</a>

## Contractual warranty

Warranty	18 months
----------	-----------

Dimensions

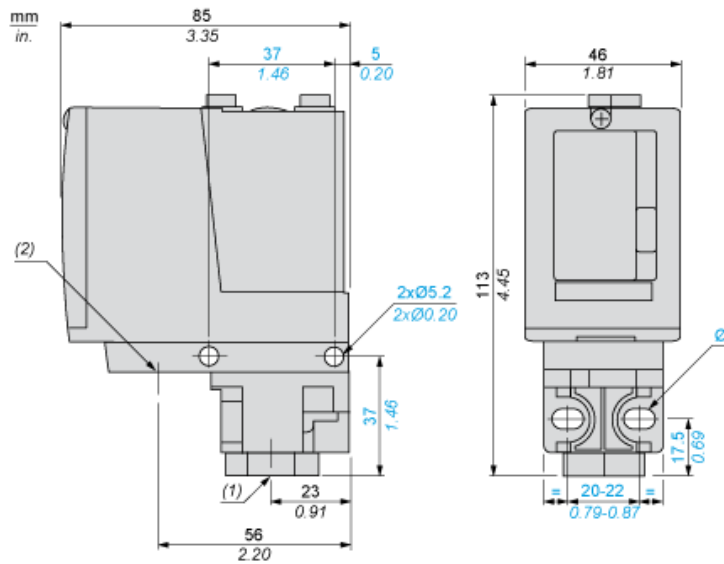

- (1) 1 fluid entry, tapped G1/4 (BSP female)  
(2) 1 electrical connections entry, tapped Pg 13.5  
 $\varnothing$ : 2 elongated holes  $\varnothing$  5.2 x 6.7

---

## Wiring Diagram

---

### Terminal Model

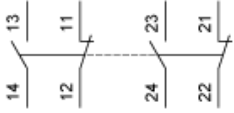

Operating Curves

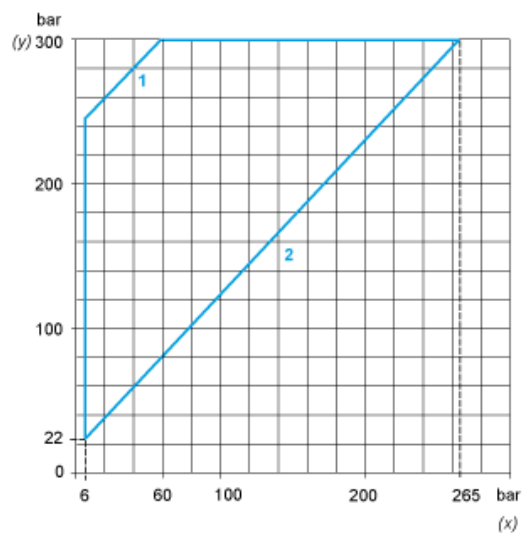

- (y) Rising pressure
- (x) Falling pressure
- 1 : Maximum differential
- 2 : Minimum differential

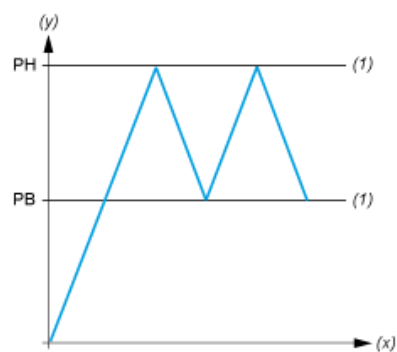

- (y) Pressure
- (x) Time
- (1) Adjustable value
- PH : High point
- PB : Below point