



## Main

Range of product	OsiSense XM
Pressure sensor type	Electromechanical pressure sensor
Pressure sensor name	XM 6
Pressure rating	6 bar
Contacts type and composition	1 C/O snap action
Controlled fluid	Air (0...70 °C) Fresh water (0...70 °C) Sea water (0...70 °C)
Fluid connection type	G 1/4 (female) conforming to ISO 228
Cable entry	2 entries tapped for Pg 13.5 cable gland conforming to NF C 68-300
Electrical connection	Screw-clamp terminals, clamping capacity: 1 x 1...2 x 2.5 mm <sup>2</sup>
Electrical circuit type	Control circuit
[In] rated current	3 A (U <sub>e</sub> = 120 V), AC-15, B300 1.5 A (U <sub>e</sub> = 240 V), AC-15, B300 0.1 A (U <sub>e</sub> = 250 V), DC-13, R300
Setting	Internal
Colour of cover	Black opaque
Pressure switch type of operation	Regulation between 2 thresholds
Scale type	Fixed differential
Local display	Without
Enclosure material	PC impregnated with Lexan 500R
Adjustable range of switching point on rising pressure	1...6 bar
Adjustable range of switching point on falling pressure	0.2...4.8 bar
Pressure actuator	Diaphragm
Possible differential minimum at high setting	1.2 bar
Possible differential minimum at low setting	0.8 bar
Destruction pressure	30 bar
Materials in contact with fluid	Canvas covered nitrile Chromated zinc alloy
Maximum permissible accidental pressure	13.5 bar

## Complementary

Height	106 mm
Width	57 mm
Depth	97.5 mm
Operating position	Any position
Maximum permissible pressure - per cycle	7.5 bar
Short-circuit protection	10 A cartridge fuse, type gG (gl)
Maximum operating rate	10 cyc/mn
[Ui] rated insulation voltage	500 V conforming to EN/IEC 60947-1

[Uimp] rated impulse withstand voltage	6 kV EN/IEC 60947-1
Electrical durability	1000000 cycles, 50/60 Hz, AC-15, 240 V / 3 A, Ith = 10 A
Mechanical durability	1000000 cycles
Repeat accuracy	3.5 %
Net weight	0.43 kg



## Environment

Standards	CE EN/IEC 60947-5-1
Product certifications	CSA UL CCC
Ambient air temperature for operation	-25...70 °C
Ambient air temperature for storage	-40...70 °C
Protective treatment	TC
Electrical shock protection class	Class I conforming to IEC 536
IP degree of protection	IP54 conforming to EN/IEC 60529

## Packing Units

Unit Type of Package 1	PCE
Number of Units in Package 1	1
Package 1 Weight	491 g
Package 1 Height	6 cm
Package 1 width	11.5 cm
Package 1 Length	17 cm
Unit Type of Package 2	S03
Number of Units in Package 2	20
Package 2 Weight	10.3 kg
Package 2 Height	30 cm
Package 2 width	30 cm
Package 2 Length	40 cm

## Offer Sustainability

Sustainable offer status	Green Premium product
REACH Regulation	 <a href="#">REACH Declaration</a>
EU RoHS Directive	Pro-active compliance (Product out of EU RoHS legal scope)  <a href="#">EU RoHS Declaration</a>
Mercury free	Yes
RoHS exemption information	 <a href="#">Yes</a>
Environmental Disclosure	 <a href="#">Product Environmental Profile</a>

## Contractual warranty

Warranty	18 months
----------	-----------

Dimensions

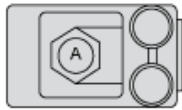
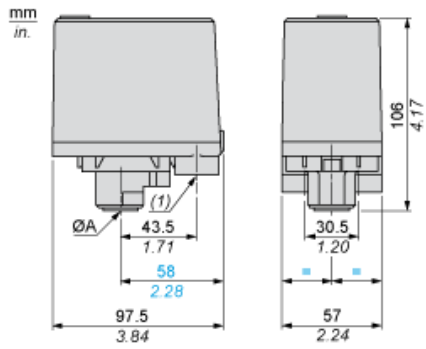

- (A) G 1/4 (female)
- (1) 2 tapped entries PG 13.5

---

Minimum Mounting Clearance

---

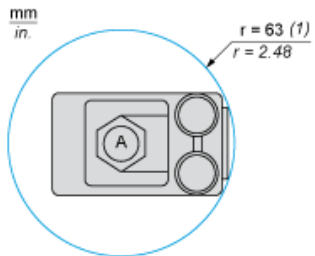

(ØA) G 1/4 (female)

(1) Minimum clearance zone for screwing-on pressure switch at point A

---

Wiring Diagram

---

Connections



Curves

Operating Curves

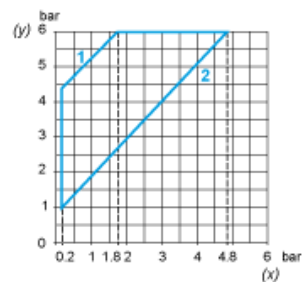

- (y) Rising pressure
- (x) Falling pressure
- 1 : Maximum differential
- 2 : Minimum differential

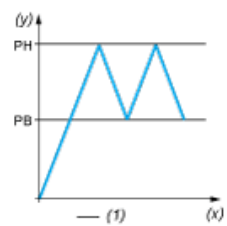

- (y) Pressure
- (x) Time
- (1) Adjustable value