

XMLA010C2S12

Electromechanical pressure sensor, Pressure sensors XM, switch XMLA 10 bar, fixed scale 1 threshold, 1 C/O



Main

Range of product	OsiSense XM
Product or component type	Electromechanical pressure sensor
Pressure sensor type	Electromechanical pressure sensor
Device short name	XMLA
Pressure rating	10 bar
Controlled fluid	Corrosive fluid (0...160 °C)
Fluid connection type	G 1/4 (female) conforming to ISO 228
Electrical connection	Screw-clamps terminals, 1 x 0.5...2 x 2.5 mm ²
AWG gauge	AWG 20...AWG 14
Cable entry	Cable gland 7...13 mm
Contacts type and composition	1 C/O
Product specific application	-
Pressure switch type of operation	Detection of 1 single threshold
Electrical circuit type	Control circuit
Scale type	Fixed differential
Local display	With
Adjustable range of switching point on rising pressure	0.6...10 bar
Adjustable range of switching point on falling pressure	0.1...9.5 bar
Maximum permissible accidental pressure	22.5 bar
Destruction pressure	45 bar
Pressure actuator	Diaphragm
Materials in contact with fluid	PTFE 316L stainless steel
Enclosure material	Zinc alloy
[In] rated current	3 A, B300, AC-15 (U _e = 120 V) conforming to EN/IEC 60947-5-1 1.5 A, B300, AC-15 (U _e = 240 V) conforming to EN/IEC 60947-5-1 0.1 A, R300, DC-13 (U _e = 250 V) conforming to EN/IEC 60947-5-1

Complementary

Natural differential at low setting	0.5 bar (+/- 0.05 bar)
Natural differential at high setting	0.5 bar (+/- 0.05 bar)
Maximum permissible pressure - per cycle	12.5 bar
Terminal block type	4 terminals
Maximum operating rate	120 cyc/mn
Repeat accuracy	2 %
[Ui] rated insulation voltage	300 V conforming to UL 508 500 V conforming to EN/IEC 60947-1 300 V conforming to CSA C22.2 No 14

The information provided in this documentation contains general descriptions and/or technical characteristics of the performance of the products contained herein. This documentation is not intended as a substitute for and is not to be used for determining suitability or reliability of these products for specific user applications. It is the duty of any such user or integrator to perform the appropriate and complete risk analysis, evaluation and testing of the products with respect to the relevant specific application or use thereof. Neither Schneider Electric Industries SAS nor any of its affiliates or subsidiaries shall be responsible or liable for misuse of the information contained herein.

[Uimp] rated impulse withstand voltage	EN/IEC 60947-1 6 kV
Auxiliary contacts operation	Snap action
Contacts material	Silver contacts
Maximum resistance across terminals	25 MOhm conforming to IEC 255-7 category 3 25 mOhm conforming to NF C 93-050 method A
Short-circuit protection	10 A cartridge fuse, type gG (gl)
Mechanical durability	5000000 cycles
Setting	External
Height	113 mm
Depth	75 mm
Width	35 mm
Net weight	0.685 kg





Environment

Standards	CE CSA C22.2 No 14 EN/IEC 60947-5-1 UL 508
Product certifications	UL BV EAC CCC CSA LROS (Lloyds register of shipping)
Protective treatment	TC standard version
Ambient air temperature for operation	-25...70 °C
Ambient air temperature for storage	-40...70 °C
Operating position	Any position
Vibration resistance	4 gn conforming to IEC 60068-2-6 (f = 30...500 Hz)
Shock resistance	50 gn conforming to IEC 60068-2-27
Electrical shock protection class	Class I conforming to IEC 1140 Class I conforming to IEC 536 Class I conforming to NF C 20-030
IP degree of protection	IP66 conforming to EN/IEC 60529

Packing Units

Unit Type of Package 1	PCE
Number of Units in Package 1	1
Package 1 Weight	712 g
Package 1 Height	4.2 cm
Package 1 width	12.5 cm
Package 1 Length	8 cm

Offer Sustainability

Sustainable offer status	Green Premium product
REACH Regulation	 REACH Declaration
EU RoHS Directive	Pro-active compliance (Product out of EU RoHS legal scope)  EU RoHS Declaration
Mercury free	Yes
RoHS exemption information	 Yes
Environmental Disclosure	 Product Environmental Profile

Contractual warranty

Warranty	18 months
----------	-----------

Dimensions

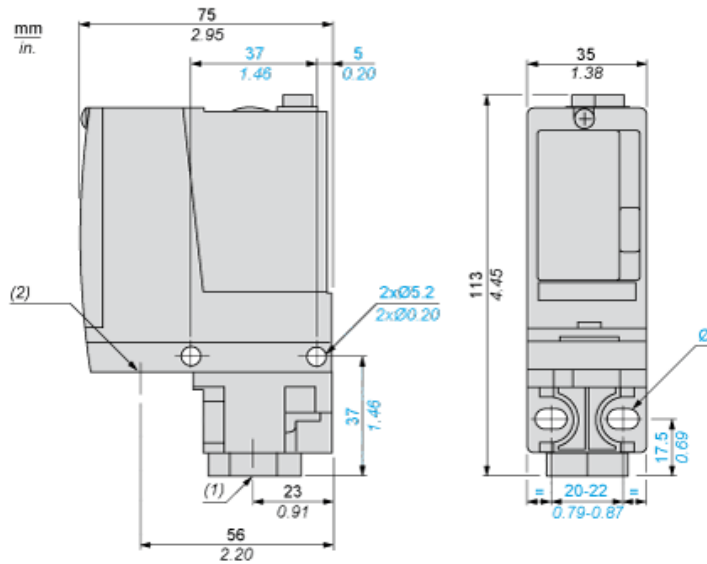

- (1) 1 fluid entry, tapped G1/4 (BSP female)
- (2) 1 electrical connections entry, tapped M20 x 1.5
- Ø : 2 elongated holes Ø 5.2 x 6.7

Wiring Diagram

Terminal Model



Operating Curves

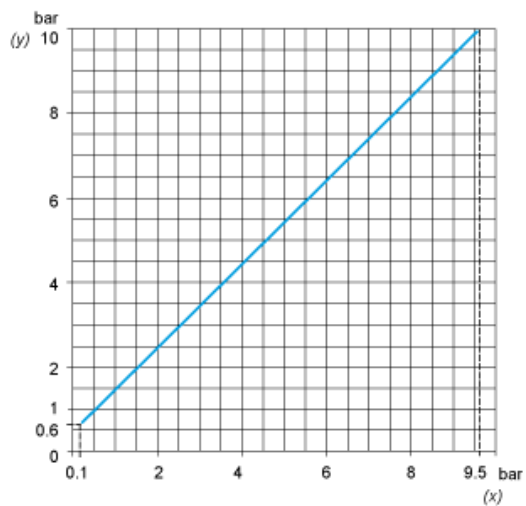

(y) Rising pressure
(x) Falling pressure

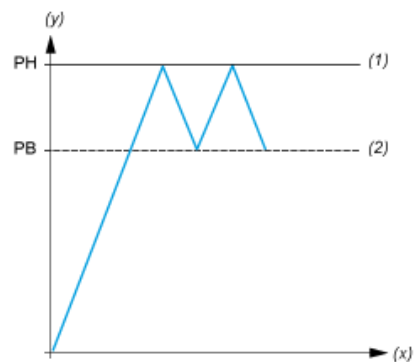

(y) Pressure
(x) Time
(1) Adjustable value
(2) Non adjustable value
PH : High point
PB : Below point