



## Main

Range of product	OsiSense XM
Product or component type	Electromechanical pressure sensor
Pressure sensor type	Electromechanical vacuum sensor
Device short name	XMLB
Pressure rating	-1 bar
Controlled fluid	Air (0...70 °C) Fresh water (0...70 °C) Hydraulic oil (0...70 °C)
Fluid connection type	G 1/4 (female) conforming to ISO 228
Electrical connection	Screw-clamps terminals, 1 x 0.5...2 x 2.5 mm <sup>2</sup>
AWG gauge	AWG 20...AWG 14
Cable entry	Cable gland 7...13 mm
Contacts type and composition	1 C/O
Product specific application	-
Pressure switch type of operation	Regulation between 2 thresholds
Electrical circuit type	Control circuit
Scale type	Adjustable differential
Local display	With
Adjustable range of switching point on rising pressure	-0.87...-0.01 bar
Adjustable range of switching point on falling pressure	-1...-0.14 bar
Possible differential maximum at high setting	0.8 bar
Maximum permissible accidental pressure	9 bar
Destruction pressure	18 bar
Pressure actuator	Diaphragm
Materials in contact with fluid	Zinc alloy Nitrile 304L stainless steel
Enclosure material	Zinc alloy
[In] rated current	3 A, B300, AC-15 (Ue = 120 V) conforming to EN/IEC 60947-5-1 1.5 A, B300, AC-15 (Ue = 240 V) conforming to EN/IEC 60947-5-1 0.1 A, R300, DC-13 (Ue = 250 V) conforming to EN/IEC 60947-5-1

## Complementary

Possible differential minimum at low setting	0.13 bar (+/- 0.02 bar)
Possible differential minimum at high setting	0.13 bar (+/- 0.02 bar)
Maximum permissible pressure - per cycle	5 bar
Terminal block type	4 terminals
Maximum operating rate	120 cyc/mn
Repeat accuracy	2 %

[Ui] rated insulation voltage	300 V conforming to UL 508 500 V conforming to EN/IEC 60947-1 300 V conforming to CSA C22.2 No 14
[Uimp] rated impulse withstand voltage	6 kV EN/IEC 60947-1
Auxiliary contacts operation	Snap action
Contacts material	Silver contacts
Maximum resistance across terminals	25 MOhm conforming to IEC 255-7 category 3 25 mOhm conforming to NF C 93-050 method A
Short-circuit protection	10 A cartridge fuse, type gG (gl)
Mechanical durability	3000000 cycles
Setting	External
Height	158 mm
Depth	77.5 mm
Width	55 mm
Net weight	1.015 kg





## Environment

Standards	EN/IEC 60947-5-1 CE CSA C22.2 No 14 UL 508
Product certifications	LROS (Lloyds register of shipping) CCC CSA EAC UL BV
Protective treatment	TC standard version
Ambient air temperature for operation	-25...70 °C
Ambient air temperature for storage	-40...70 °C
Operating position	Any position
Vibration resistance	4 gn conforming to IEC 60068-2-6 (f = 30...500 Hz)
Shock resistance	50 gn conforming to IEC 60068-2-27
Electrical shock protection class	Class I conforming to IEC 1140 Class I conforming to IEC 536 Class I conforming to NF C 20-030
IP degree of protection	IP66 conforming to EN/IEC 60529

## Packing Units

Package 1 Weight	1.022 kg
Package 1 Height	0.600 dm
Package 1 width	1.450 dm
Package 1 Length	0.800 dm

## Offer Sustainability

Sustainable offer status	Green Premium product
REACH Regulation	 <a href="#">REACH Declaration</a>
EU RoHS Directive	Pro-active compliance (Product out of EU RoHS legal scope)  <a href="#">EU RoHS Declaration</a>
Mercury free	Yes
RoHS exemption information	 Yes
Environmental Disclosure	 <a href="#">Product Environmental Profile</a>

## Contractual warranty

Warranty	18 months
----------	-----------

Dimensions

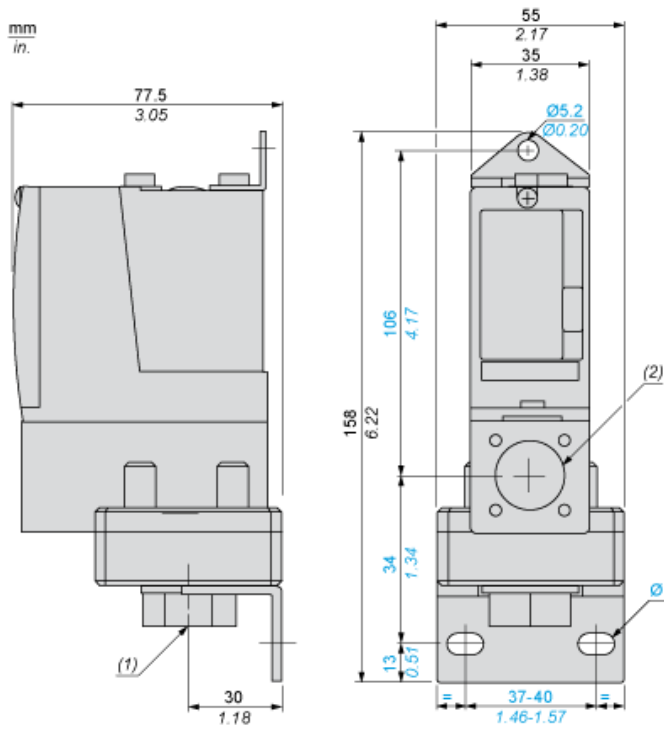

- (1) 1 fluid entry, tapped G1/4 (BSP female)
- (2) 1 electrical connections entry, tapped M20 x 1.5
- Ø : 2 elongated holes Ø 10.2 x 5.2

---

## Wiring Diagram

---

### Terminal Model



Operating Curves

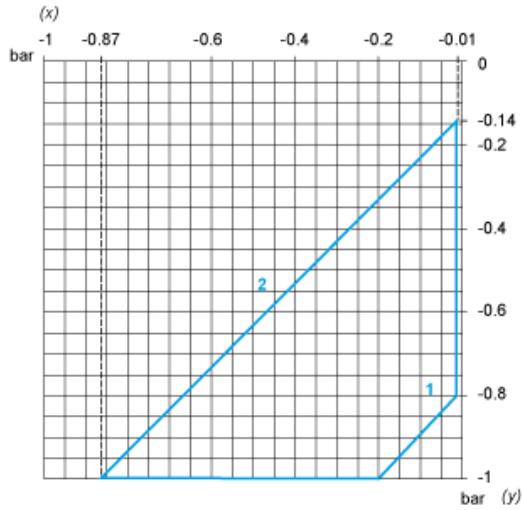

- (x) Rising pressure
- (y) Falling pressure
- 1 : Maximum differential
- 2 : Minimum differential

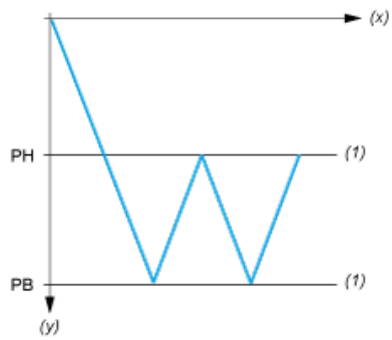

- (x) Time
- (y) Vacuum
- (1) Adjustable value
- PH : High point
- PB : Below point