

# XMPE12C2131

Pressure sensors XM, pressure sensor XMP,  
12 bar, G 1/4 female, 3 NC, ON/OFF knob  
control



## Main

Range of product	OsiSense XM
Pressure sensor type	Electromechanical pressure sensor
Pressure sensor name	XMP
Pressure rating	12 bar
Fluid connection type	G 1/4 (female) conforming to ISO 228
Controlled fluid	Air (0...70 °C) Fresh water (0...70 °C) Sea water (0...70 °C)
Cable entry	2 entries tapped for Pg 13.5 cable gland conforming to NF C 68-300
Contacts type and composition	3 NC snap action
Product specific application	-
Pressure switch type of operation	Regulation between 2 thresholds
Electrical connection	Screw-clamp terminals, clamping capacity: minimum : 2 x 4 mm <sup>2</sup>
Electrical circuit type	Power circuit
Scale type	Adjustable differential
Local display	Without
Sale per indivisible quantity	1

## Complementary

Adjustable range of switching point on falling pressure	0.3...10.3 bar
Adjustment range high setting	1.3...12 bar
Possible differential minimum at low setting	1 bar
Possible differential minimum at high setting	1.7 bar
Possible differential maximum at high setting	8.4 bar
Destruction pressure	30 bar
Type of decompression valve	Straight valve instant connection
Control type	ON/OFF knob
Terminal block type	6 terminals
Pressure actuator	Diaphragm
Materials in contact with fluid	Canvas covered nitrile Chromated zinc alloy
Enclosure material	PA impregnated with fibreglass
Operating position	Any position
Maximum operating rate	10 cyc/mn
Repeat accuracy	3.5 %
[Ui] rated insulation voltage	500 V conforming to EN/IEC 60947-1
[Uimp] rated impulse withstand voltage	6 kV EN/IEC 60947-1
Maximum resistance across terminals	25 MOhm conforming to IEC 60255-7 category 3 25 MOhm conforming to NF C 93-050 method A

The information provided in this documentation contains general descriptions and/or technical characteristics of the performance of the products contained herein. This documentation is not intended as a substitute for and is not to be used for determining suitability or reliability of these products for specific user applications. It is the duty of any such user or integrator to perform the appropriate and complete risk analysis, evaluation and testing of the products with respect to the relevant specific application or use thereof. Neither Schneider Electric Industries SAS nor any of its affiliates or subsidiaries shall be responsible or liable for misuse of the information contained herein.

Electrical durability	1000000 Cycles 1.5 kW, operating rate <10 cyc/mn, load factor: 0.4, 400 V AC 3 phases 500000 Cycles 3 kW, operating rate <10 cyc/mn, load factor: 0.4, 400 V AC 3 phases 600000 Cycles 1.5 kW, operating rate <10 cyc/mn, load factor: 0.4, 230 V AC 3 phases 700000 cycles 2.2 kW, operating rate <10 cyc/mn, load factor: 0.4, 400 V AC 3 phases
Mechanical durability	1000000 cycles
Setting	Nut
Net weight	0.45 kg
Terminals description ISO n°1	(5-6)NC (1-2)NC (3-4)NC
Depth	98 mm
Height	138 mm
Width	57 mm





## Environment

Product certifications	EAC
Standards	EN/IEC 60947-4-1 CE
Ambient air temperature for operation	-25...70 °C
Ambient air temperature for storage	-40...70 °C
Vibration resistance	3 gn conforming to IEC 60068-2-6 (f = 10...500 Hz)
Shock resistance	50 gn conforming to IEC 60068-2-27
Electrical shock protection class	Class I conforming to IEC 60536
IP degree of protection	IP54 conforming to EN/IEC 60529

## Packing Units

Unit Type of Package 1	PCE
Number of Units in Package 1	1
Package 1 Weight	530 g
Package 1 Height	6.2 cm
Package 1 width	11.5 cm
Package 1 Length	17 cm
Unit Type of Package 2	S03
Number of Units in Package 2	20
Package 2 Weight	10.976 kg
Package 2 Height	30 cm
Package 2 width	30 cm
Package 2 Length	40 cm

## Offer Sustainability

Sustainable offer status	Green Premium product
REACH Regulation	 <a href="#">REACH Declaration</a>
EU RoHS Directive	Pro-active compliance (Product out of EU RoHS legal scope)  <a href="#">EU RoHS Declaration</a>
Mercury free	Yes
RoHS exemption information	 <a href="#">Yes</a>
Environmental Disclosure	 <a href="#">Product Environmental Profile</a>

## Contractual warranty

Warranty	18 months
----------	-----------

## Dimensions

### With Straight, Instant Connection, Decompression Valve

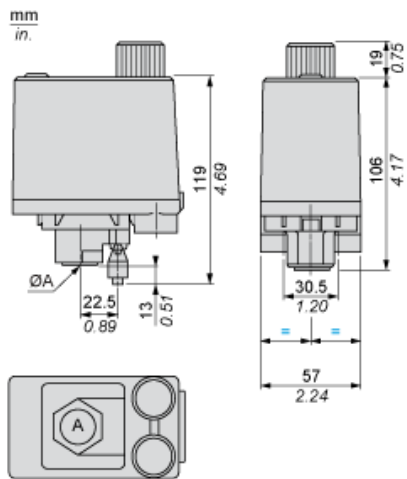

$\varnothing A = G 1/4$

(1) 2 tapped entries for Pg 13.5

---

Minimum Mounting Clearance

---

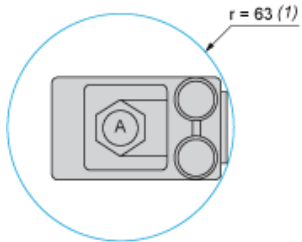

ØA = G1/4

(1) Minimum clearance zone for screwing-on pressure switch at point A

---

## Wiring Diagram

---

### Terminal Connections

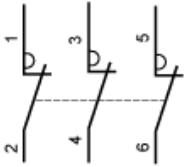

Curves

Operating Curves

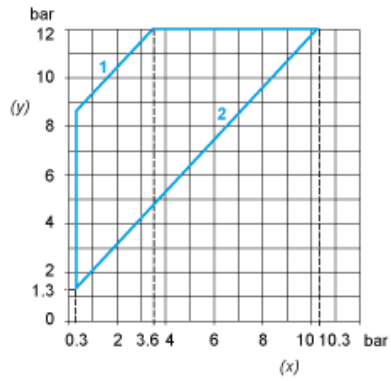

- (y) Rising pressure
- (x) Falling pressure
- 1 : Maximum differential
- 2 : Minimum differential

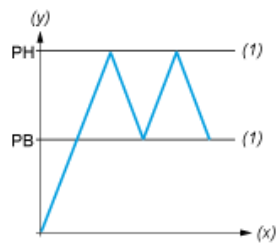

- (y) Pressure
- (x) Time
- (1) Adjustable value
- PH : High point
- PB : Below point